

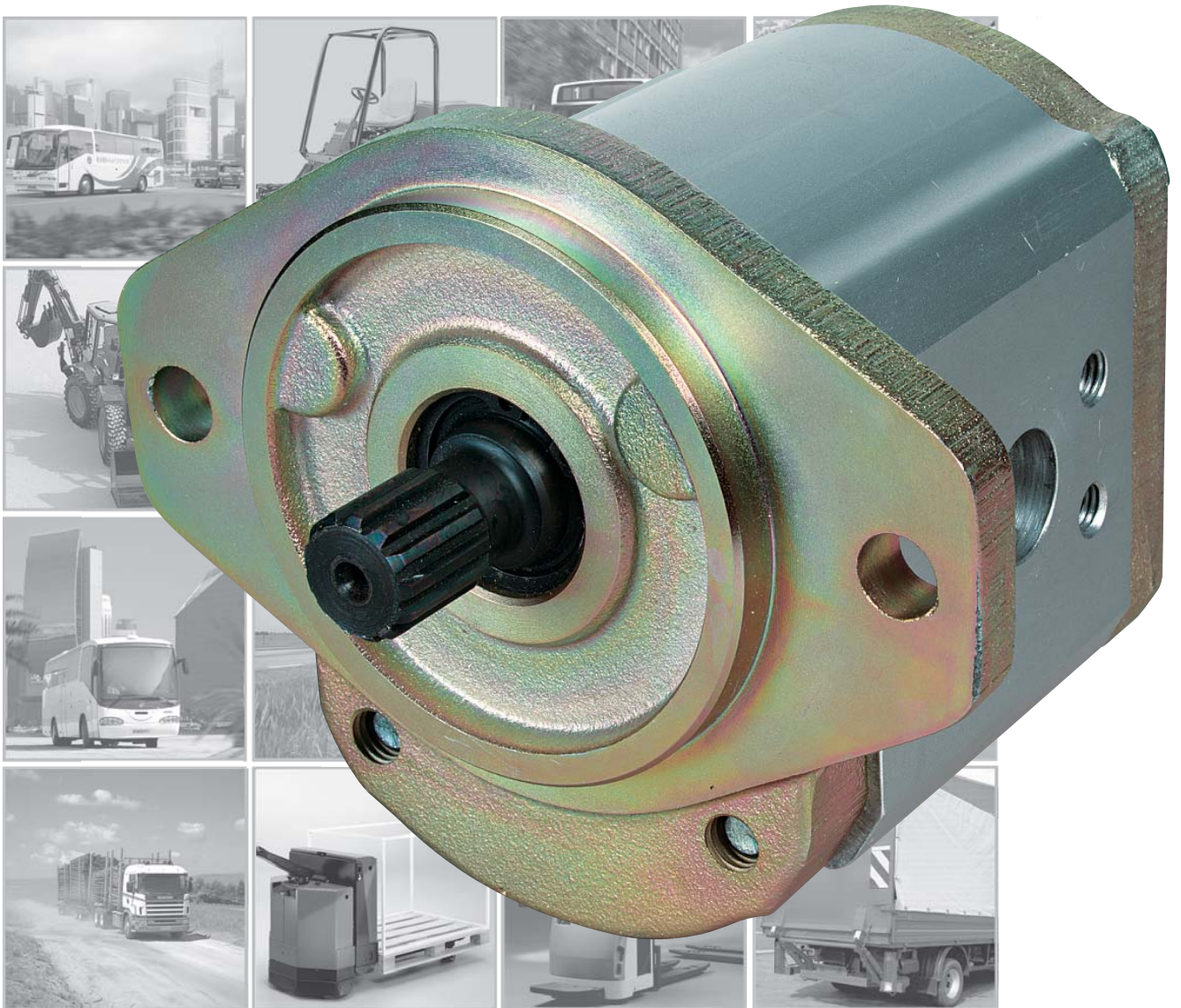

HIGH PRESSURE GEAR PUMP W1500





THE POWER OF THE W1500 B SERIES

Concentric is one of the world's leading manufacturers of hydraulic pumps. Our focus on important strategic markets such as trucks, construction equipment and materials handling has brought results: a series of high-performance hydraulic pumps. The W1500 series builds on the versatile technical platform represented by the W series.

W1500 High Pressure Gear Pumps are optimized for demanding work, with harsh weather conditions, rugged operations and long service intervals. The W1500 series is a range of cost-efficient small pumps for all applications in which the customer's demands for quality and accessibility are particularly high.

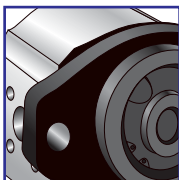

FLANGE CODE 20, 22, 23

4-9

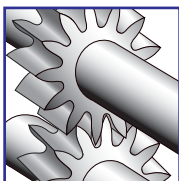

EFFICIENCIES

10-11

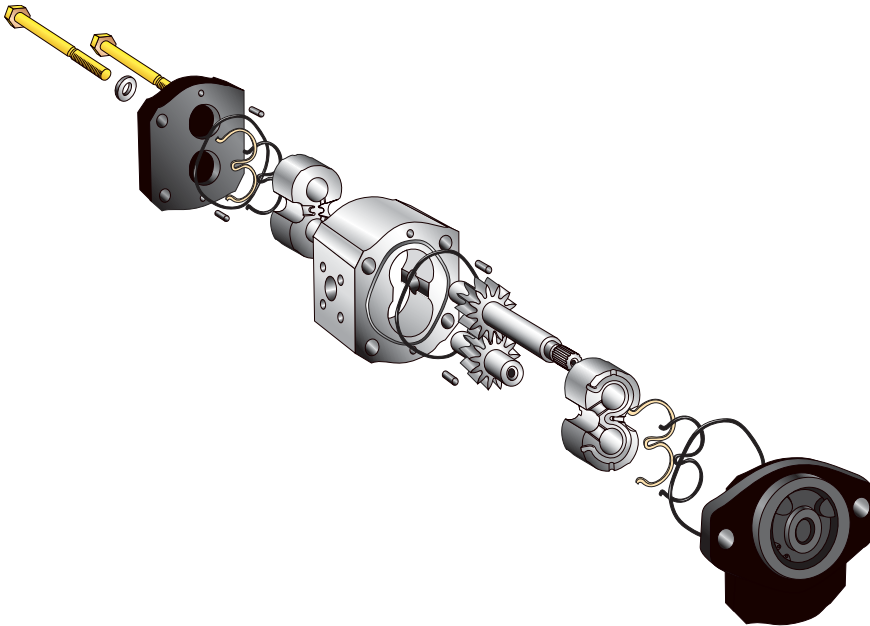

Model code example for a double pump

WP 15 A 1 B 190 R 04 DA 158 N N
 ① ② ③ ④ ⑤ ⑥ ⑦ ⑧ ⑨ ⑩ ⑪ ⑫

- | | |
|------------------------------|---------------------|
| ① = Type | ⑦ = Rotation |
| ② = Series | ⑧ = Mounting flange |
| ③ = Design | ⑨ = Drive shaft |
| ④ = # of sections | ⑩ = Portings |
| ⑤ = Seal material | ⑪ = Valve options |
| ⑥ = Displacement per section | ⑫ = 'N' Specials |

W1500 DESCRIPTION

The W1500 pumps come in single or multiple configuration of up to four sections. The basic pump is of a three piece modular design. Mounting flange and rear cover are of cast iron. The pump body is manufactured from high strength aluminium alloy.

For optimum strength, gears and shafts are precision machined from one piece steel forgings. The 14-tooth gear geometry has been optimized for low noise level.

All shaft bearing surfaces are Teflon® coated and sizes are calculated for long service life. They are continually cooled and lubricated by a controlled flow of fresh oil. This enables operation across a wide speed range at very high loads.

Multiple pumps in the W1500 range are very compact. The drive shaft is capable of transmitting high torque even to the rear section. Each section has its own inlet and pressure ports.

A wide range of mounting flanges and port sizes are available to meet all international standards.

General data

Displacement V	19 ... 50cm ³
Speed n	500 ... 3300 rpm
Pressure rated pressure p_i	up to 276 bar
intermettent pressure p_{ii}	up to 300 bar
Peak pressure p_{ii}	up to 330 bar
Operating temperatures t	up to 105° C
Average volumetric efficiency	97%

The maximum values for n , p_i and t for a given pump specification may be applied simultaneously.

Options

- SAE mounting flange, through bolt model.
- Splined, tapered or straight shaft with key, tang shaft.
- Thread ports of flange ports.
- Clockwise or anti-clockwise rotation.
- Integrated valve features.

PERFORMANCE DATA

Operating pressure range

Inlet port:	continuous, minimum	-0,20 bar
	intermittent, minimum	-0,35 bar
	maximum	+2,00 bar

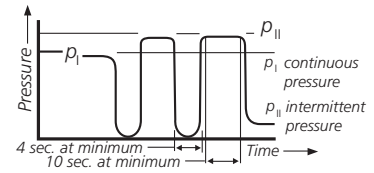

Outlet port

Product has been tested to 1,00,000 cycles at p_{ii} . Pressure p_{ii} is permitted at maxi. 20 sec loaded following 10 sec minimum unloaded. Product has been tested to 500,000 cycles at p_{ii} .

Above represents performance which can be expected from units incorporating flange flange port styles.

Speed range

Minimum speed for all pump sizes is $n = 500$ rpm at maximum pressure p_i .

Maximum speed for single pumps depends on the pump model in question and can be identified from Tables onwards for respective models.

Maximum speed for multiple pumps is the lowest one specified on Tables onwards for respective models.

Noise performance data according to DIN 45 635.

Typical levels 200 bar using mineral oil with viscosity of 40mm²/s and at temperature of 50° C at different speeds:

W15B1-38	68dB(A) at $n = 1500$ rpm
W15B1-38	74dB(A) at $n = 2300$ rpm
W15B1-38	76dB(A) at $n = 3000$ rpm

Hydraulic fluids. The use of HL- or HLP-hydraulic oil according to DIN 51 524 is recommended.

The permissible viscosity for all W3A pumps ranges from 750 to 10 mm²/s.

The permissible cold start viscosity is 2000 mm²/s.

We recommend to contact Concentric before using fire resistant or bio-degradable fluids.

Temperature range

Amb. temperature,	mini. -25° C;	maxi. +80° C
Fluid temperature,	comtinuous operation,	maxi. +90° C
	short term operation,	maxi. +105° C

Please note

Viscosities -when operating at above temperature limits-have to remain within the range specified under "Hydraulic Fluids".

Fluid cleanliness

Fluid cleanliness according to ISO 4406/1986 Code 18/14 or better is required in order to assure the pump's high level of efficiency in the long term.

Drive arrangement

Flexible couplings are preferred for direct drives. Please contact Concentric for indirect drive requirements. Pumps with outboard side load bearing are available.

Mounting position

As required.

Symbol

- Single pump
- Double pump
- Triple pump
- Quadruple pump

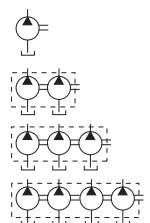

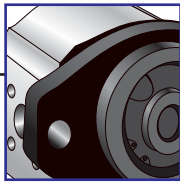

FLANGE CODE 04 (SAE A 2-bolt)

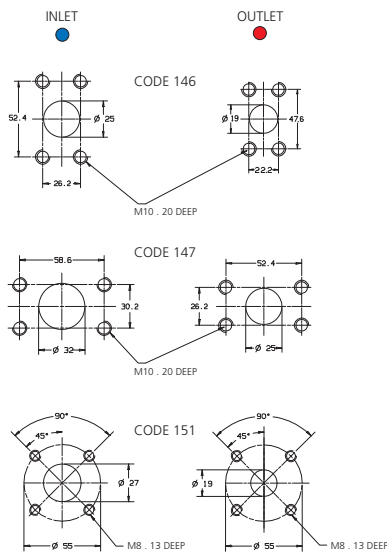
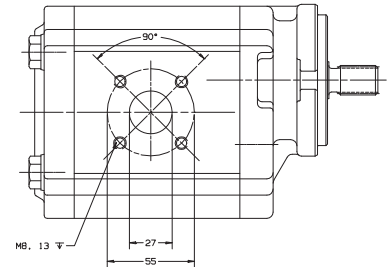
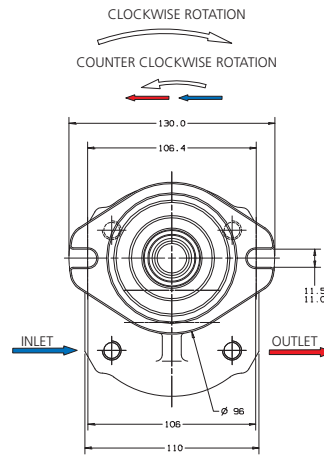
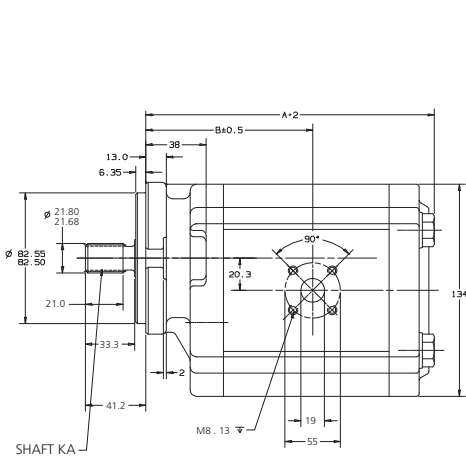

Model code example for a single pump

WP 15 A 1 B 190 R 04 KA 146 N
 ① ② ③ ④ ⑤ ⑥ ⑦ ⑧ ⑨ ⑩ ⑪

- ① = Type WP - Pump
- ② = Series 15 - 1500
- ③ = Design revision A
- ④ = # of sections
 1 - Single
 2 - Duplex
 3 - Triplex
 4 - Quadruple
- ⑤ = Seal material B - Buna
 V - Viton
- ⑥ = Displacement per section
 (See Code Displ. below)
- ⑦ = Rotation
 R - Clockwise
 L - Counter clockwise
- ⑧ = Mounting flange
 04 SAE A 2-Bolt Ø 82,5 mm pilot
- ⑨ = Drive shaft
 KA SAE B Spline 13-t
- ⑩ = Portings
 146 - 25 mm + 19 mm
 147 - 32 mm + 25 mm
 151 - 27 mm + 19 mm
- ⑪ = Valve options N - None

Size	Maximum pressure (bar) P ₁	Maximum speed (rpm)			Dimensions		Weight (approx.) kg
		Port. '146'	Port. '147'	Port. '151'	A [mm]	B [mm]	
190 - 19	276	3300	-	3300	150,0	89,3	8,0
230 - 23	276	3300	-	3300	154,2	91,4	8,3
280 - 28	276	3100	-	3100	159,4	94,0	8,4
330 - 33	276	3000	-	3000	164,6	96,6	8,6
380 - 38	276	2700	3000	3000	169,8	99,2	9,0
440 - 44	221	-	2800	2700	176,0	102,3	9,2
500 - 50	200	-	2700	2300	182,2	105,4	9,5

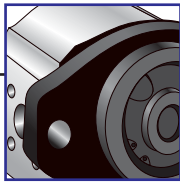

FLANGE CODE 05 (SAE B 2-bolt)

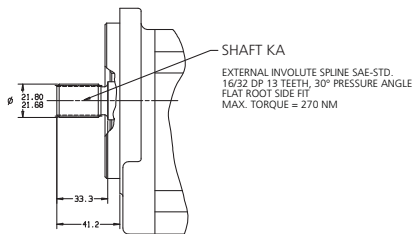
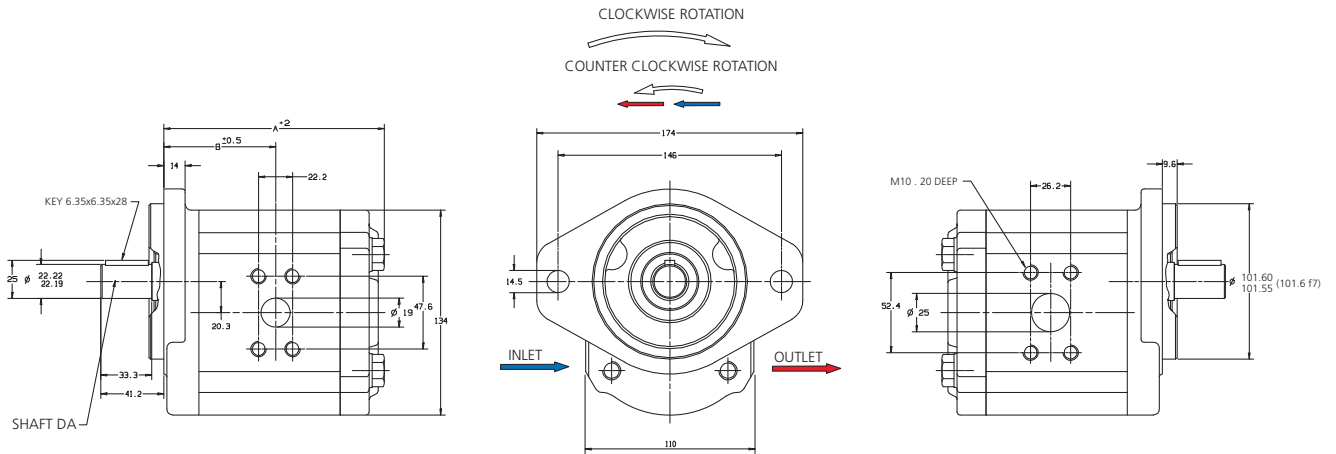

Model code example for a single pump

WP 15 A 1 B 330 R 05 DA 146 N
 ① ② ③ ④ ⑤ ⑥ ⑦ ⑧ ⑨ ⑩ ⑪

- ① = Type **WP** - Pump
- ② = Series **15** - 1500
- ③ = Design revision **A**
- ④ = # of sections
 1 - Single
 2 - Duplex
 3 - Triplex
 4 - Quadruple
- ⑤ = Seal material **B** - Buna
 V - Viton
- ⑥ = Displacement per section
 (See Code Displ. below)
- ⑦ = Rotation
R - Clockwise
L - Counter clockwise
- ⑧ = Mounting flange
05 SAE B 2-Bolt Ø 101,6 mm pilot
- ⑨ = Drive shaft
DA SAE B Straight Key Shaft
KA SAE B Spline 13-t
- ⑩ = Portings
146 - 25 mm + 19 mm
147 - 32 mm + 25 mm
151 - 27 mm + 19 mm
- ⑪ = Valve options **N** - None

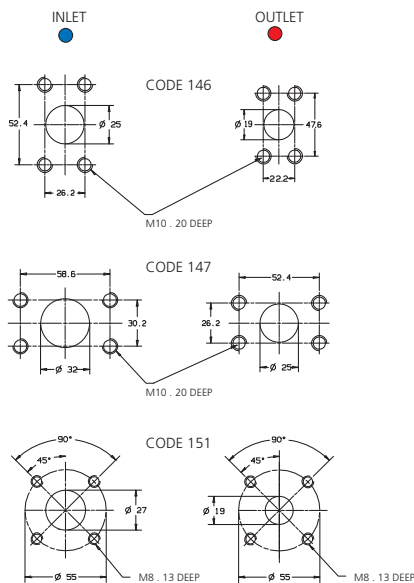

Size	Maximum pressure (bar) P ₁	Maximum speed (rpm)			Dimensions		Weight (approx.) kg
		Port. '146'	Port. '147'	Port. '151'	A [mm]	B [mm]	
190 - 19	276	3300	-	3300	124,0	63,3	8,0
230 - 23	276	3300	-	3300	128,2	65,4	8,3
280 - 28	276	3100	-	3100	133,4	68,0	8,4
330 - 33	276	3000	-	3000	138,6	70,6	8,6
380 - 38	276	2700	3000	3000	143,8	73,2	9,0
440 - 44	221	-	2800	2700	150,0	76,3	9,2
500 - 50	200	-	2700	2300	156,2	79,4	9,5

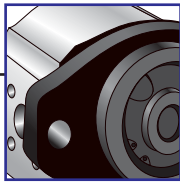

FLANGE CODE 14 (Through bolt Ø 52 mm pilot without shaft seal)

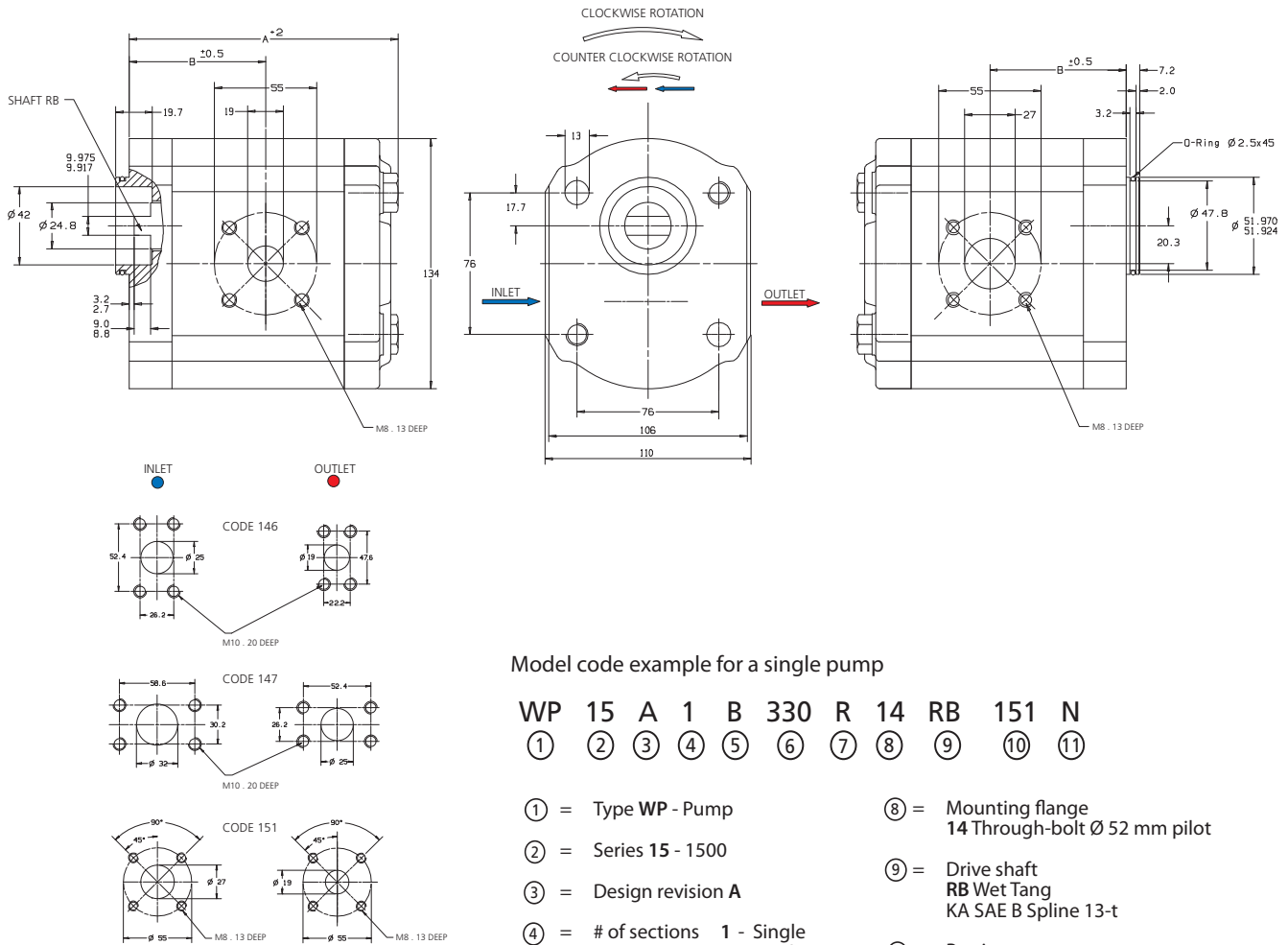

Model code example for a single pump

WP 15 A 1 B 330 R 14 RB 151 N
 ① ② ③ ④ ⑤ ⑥ ⑦ ⑧ ⑨ ⑩ ⑪

- ① = Type WP - Pump
- ② = Series 15 - 1500
- ③ = Design revision A
- ④ = # of sections 1 - Single
2 - Duplex
3 - Triplex
4 - Quadruple
- ⑤ = Seal material B - Buna
V - Viton
- ⑥ = Displacement per section
(See Code Displ. below)
- ⑦ = Rotation
R - Clockwise
L - Counter clockwise
- ⑧ = Mounting flange
14 Through-bolt Ø 52 mm pilot
- ⑨ = Drive shaft
RB Wet Tang
KA SAE B Spline 13-t
- ⑩ = Portings
146 - 25 mm + 19 mm
147 - 30,2 mm + 26,2 mm
151 - 27 mm + 19 mm
- ⑪ = Valve options N - None

Size	Maximum pressure (bar) P ₁		Maximum speed (rpm)			Dimensions		Weight (approx.) kg
	Shaft code RB	Shaft code KA	Port code 146	Port code 147	Port code 151	A [mm]	B [mm]	
190 - 19	276	276	3300	-	3300	124,0	63,3	8,0
230 - 23	276	276	3300	-	3300	128,2	65,4	8,3
280 - 28	260	276	3100	-	3100	133,4	68,0	8,4
330 - 33	220	276	3000	-	3000	138,6	70,6	8,6
380 - 38	190	276	2700	3000	3000	143,8	73,2	9,0
440 - 44	165	221	-	2800	2700	150,0	76,3	9,2
500 - 50	145	200	-	2700	2300	156,2	79,4	9,5

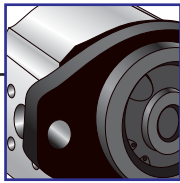

FLANGE CODE 15 (Ø 50,8 mm pilot)

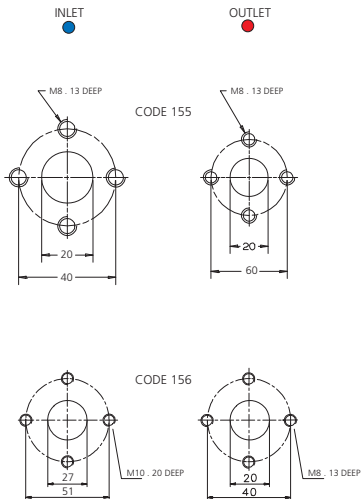
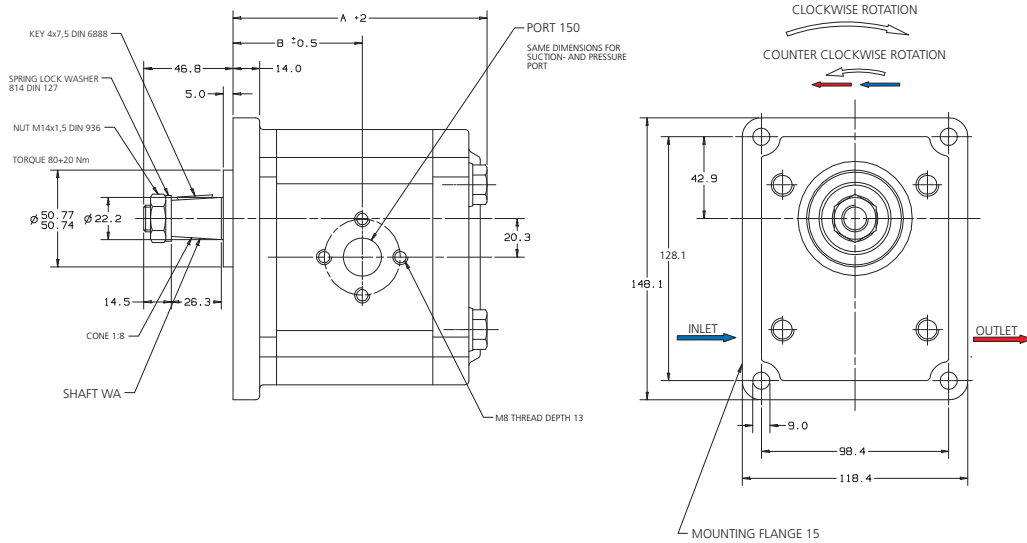

Model code example for a single pump

WP 15 A 1 B 330 R 15 WA 155 N
 ① ② ③ ④ ⑤ ⑥ ⑦ ⑧ ⑨ ⑩ ⑪

- ① = Type WP - Pump
- ② = Series 15 - 1500
- ③ = Design revision A
- ④ = # of sections 1 - Single
2 - Duplex
3 - Triplex
4 - Quadruple
- ⑤ = Seal material B - Buna
V - Viton
- ⑥ = Displacement per section
(See Code Displ. below)
- ⑦ = Rotation
R - Clockwise
L - Counter clockwise
- ⑧ = Mounting flange
15 Rect. Ø 50,8 mm pilot
- ⑨ = Drive shaft
WA Tapered 1:8, M14 x 1,5
- ⑩ = Portings
155 - 20 mm + 20 mm
156 - 27 mm + 20 mm
- ⑪ = Valve options N - None

Size	Maximum pressure (bar) P ₁ Shaft code 'WA'	Maximum speed (rpm)		Dimensions		Weight (approx.) kg
		Port code '155'	Port code '156'	A [mm]	B [mm]	
190 - 19	276	3300	-	124,0	63,3	8,0
230 - 23	276	2800	-	128,2	65,4	8,3
280 - 28	276	2300	3100	133,4	68,0	8,4
330 - 33	276	-	3000	138,6	70,6	8,6
380 - 38	276	-	3000	143,8	73,2	9,0
440 - 44	221	-	2700	150,0	76,3	9,2
500 - 50	200	-	2300	156,2	79,4	9,5

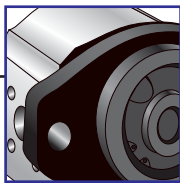

MULTIPLE PUMPS

The two following parameters are of the utmost importance when selecting multiple pumps and must never be exceeded:

- Drive shaft load index "A"
- Internal coupling load index "K"

Maxi. load index
K 10488

for double pump

$$K = (p_2 \times V_2)$$

for triple pump

$$K = (p_2 \times V_2) + (p_3 \times V_3)$$

for quadruple pump

$$K = (p_2 \times V_2) + (p_3 \times V_4) + (p_4 \times V_4)$$

-Maximum drive shaft load index "A", see table below:

for double pump

$$A = (p_1 \times V_1) + (p_2 \times V_2)$$

for triple pump

$$A = (p_1 \times V_1) + (p_2 \times V_2) + (p_3 \times V_3)$$

for quadruple pump

$$A = (p_1 \times V_1) + (p_2 \times V_2) + (p_3 \times V_3) + (p_4 \times V_4)$$

Drive shaft	Load index A	Drive shaft	Load index A
DA	20976	RB	7210
KA	18240	WA	20976

Note: p = actual pressure in bar,
V = applicable displacement in cc
from table page 4-9.

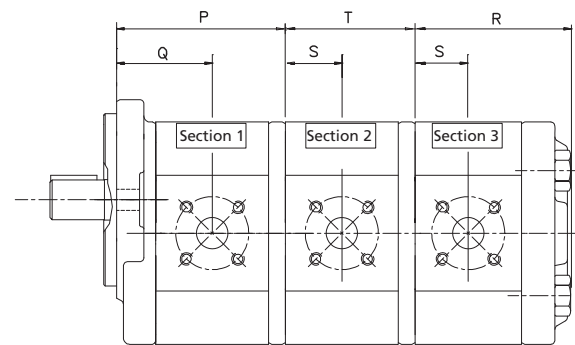
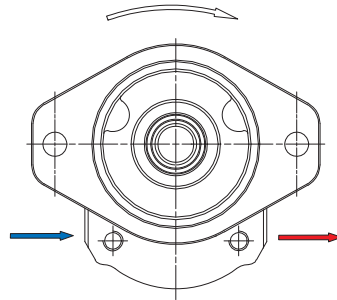
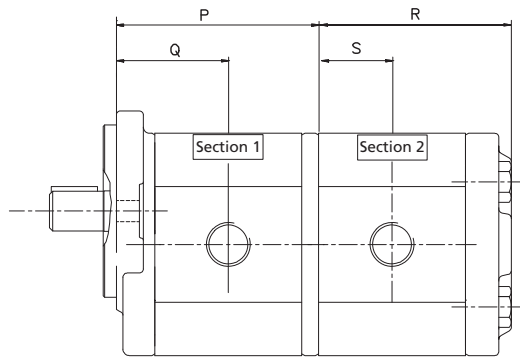

In multiple pumps, shaft end section must have largest displacement. Each consecutive section must have displacement equal to or smaller than section preceding.

Concentric multiple pumps are also available with reduced number of inlets. Please contact Concentric for details. Please, contact Concentric for pump applications requiring independently sealed sections.

W1500 plus W900 pump assemblies are possible, please contact Concentric.

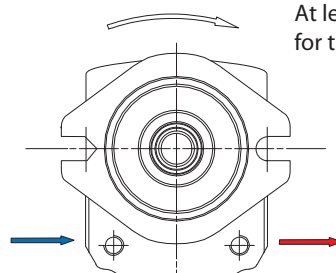
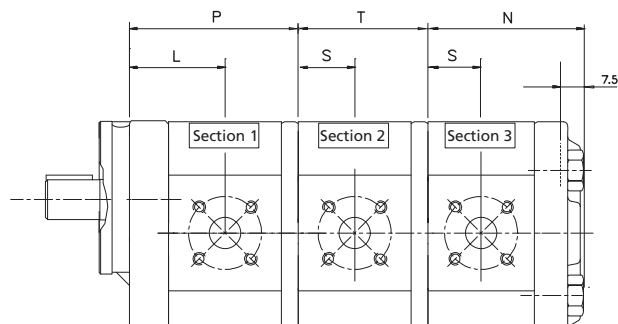

At left are shown the diverge dimensions for the SAE A flange bolt type pumps.

Size	P mm	Q mm	Shaft end section		Rear section		2nd & 3rd section		N mm	L mm	A1-section
			Weight kg	R	S	Weight kg	T	Weight kg			Weight kg
190 - 19 cc	105,5	63,3	7,0	104,5	40,3	5,0	82,5	4,1	131,5	89,3	7,4
230 - 23 cc	109,7	65,4	7,3	108,7	42,4	5,3	86,7	4,3	135,7	91,4	7,6
280 - 28 cc	114,9	68,0	7,5	112,9	45,0	5,5	91,9	4,6	140,9	94,0	7,9
330 - 33 cc	120,1	70,6	7,8	119,1	47,6	5,8	97,1	4,8	146,1	96,6	8,1
380 - 38 cc	125,3	73,2	8,1	124,3	50,2	6,1	102,3	5,1	151,3	95,2	8,4
440 - 44 cc	131,5	76,3	8,3	130,5	53,3	6,3	108,5	5,4	157,5	102,3	8,7
500 - 50 cc	137,7	79,4	9,1	136,7	56,4	7,1	114,7	6,2	163,7	105,4	9,5

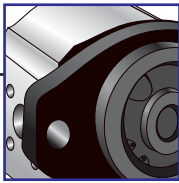

CROSS SECTION

Cross section of W1500 double pump

Common suction port for two or three pump sections is available on request.

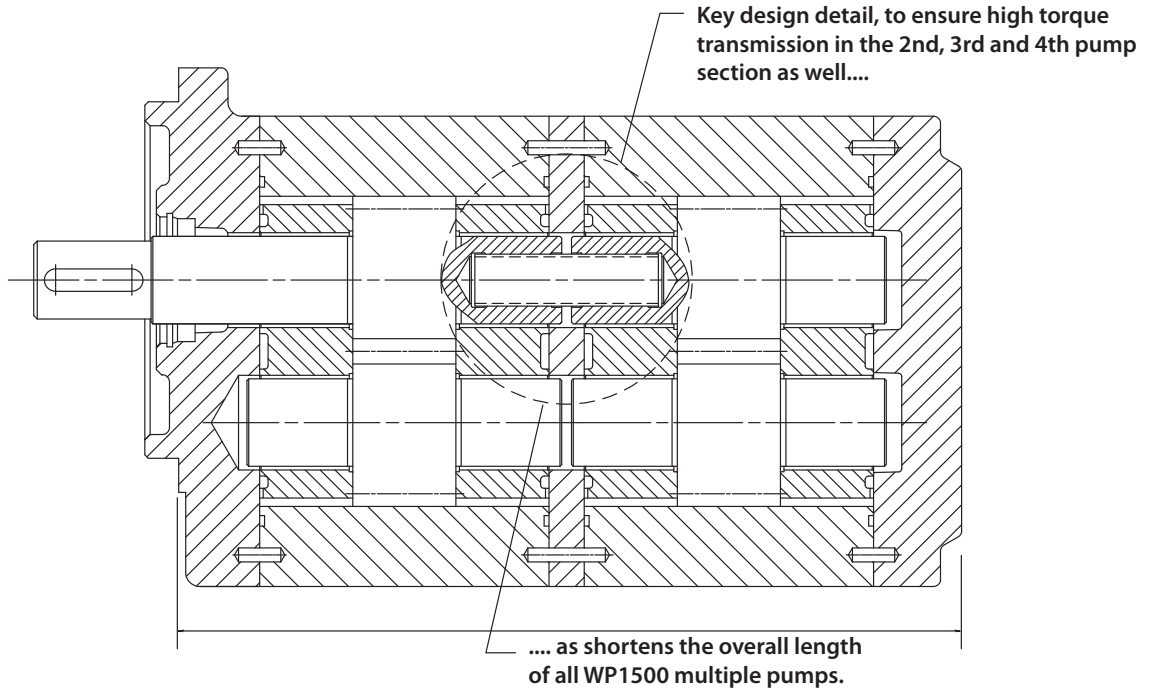

Cross section of W1500 plus W900 pump assembly

Common suction port for two or three pump sections is available on request.

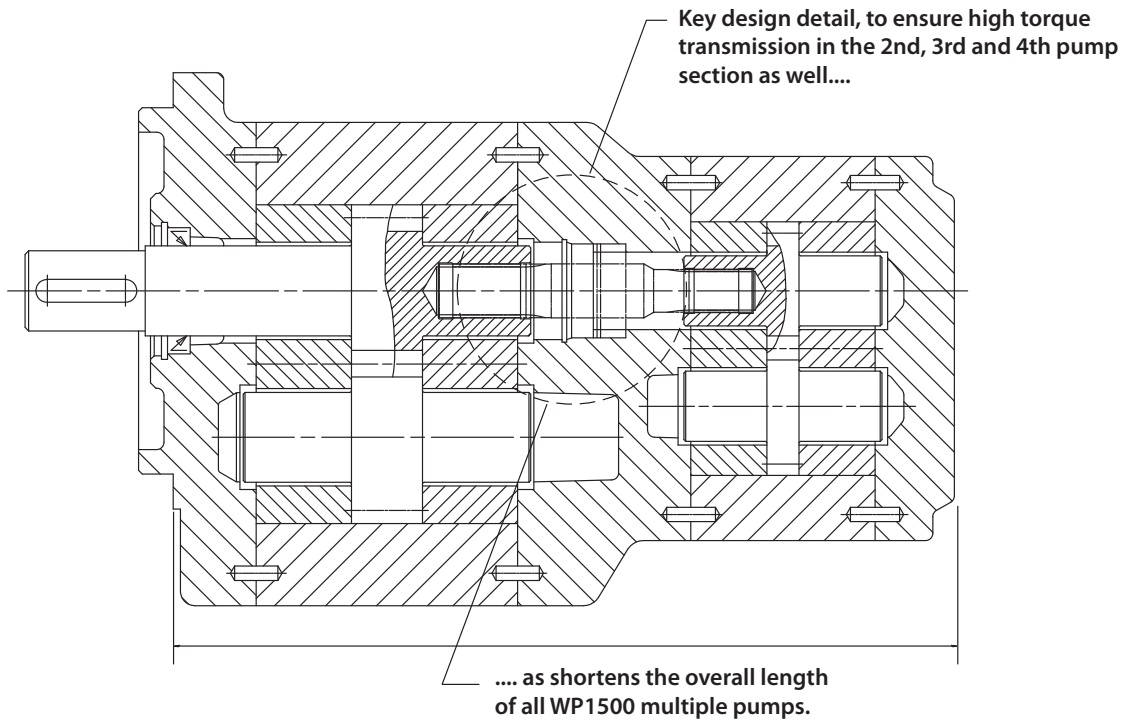

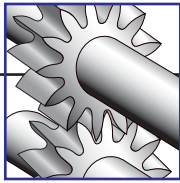

PERFORMANCE CURVES

EXPLANATION

Measuring conditions is $t = 42^{\circ}\text{C}$ (32cSt)
 Oil > ISO VG32 RENOLIN B10

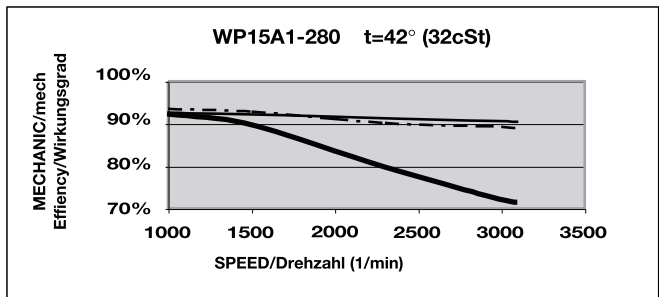
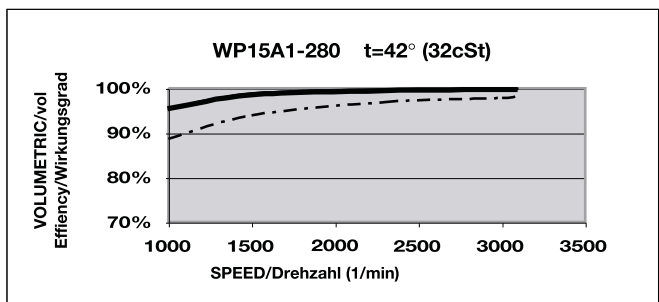
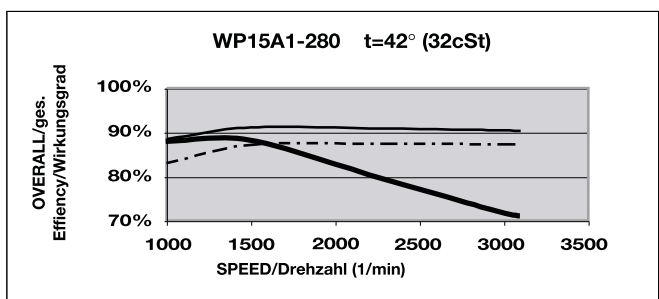
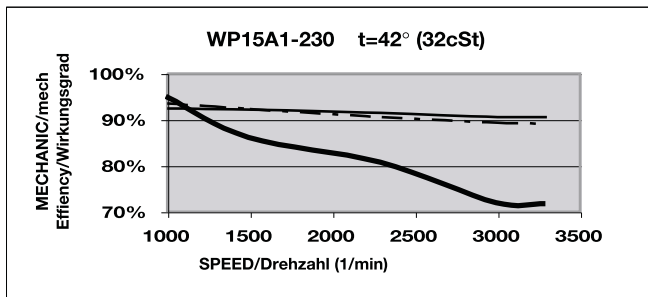
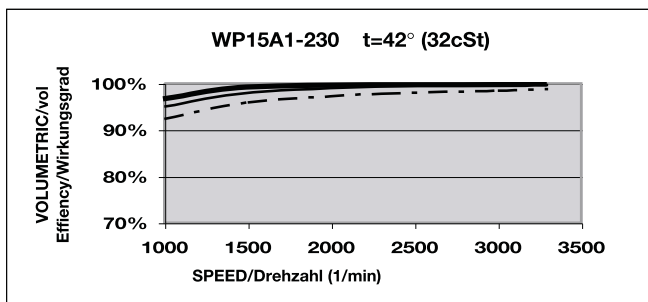
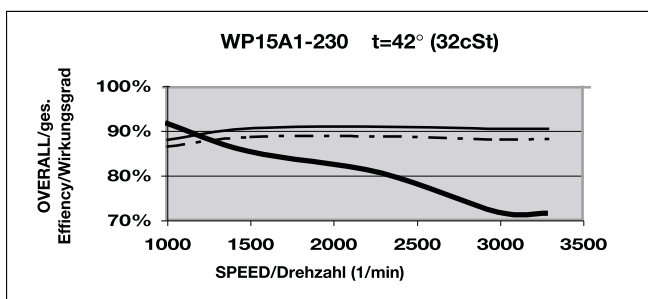
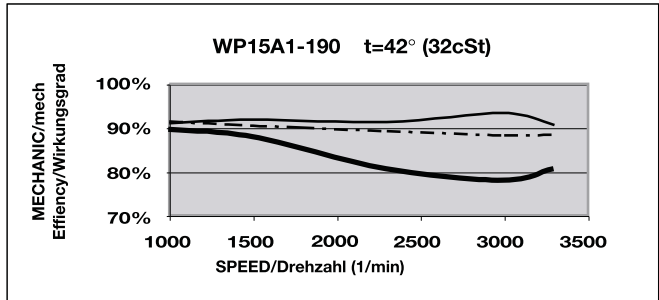
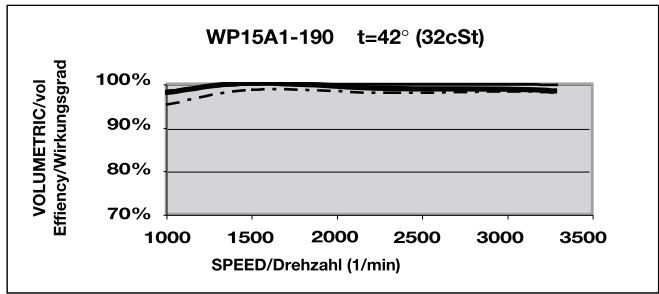
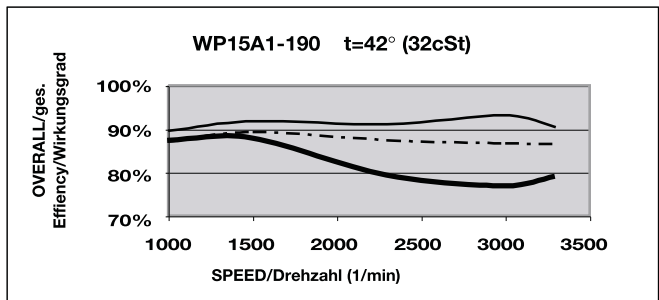

PERFORMANCE CURVES

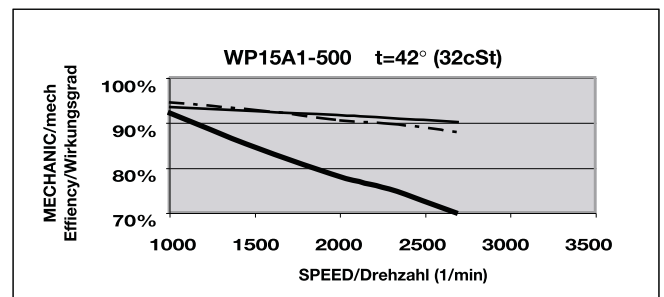
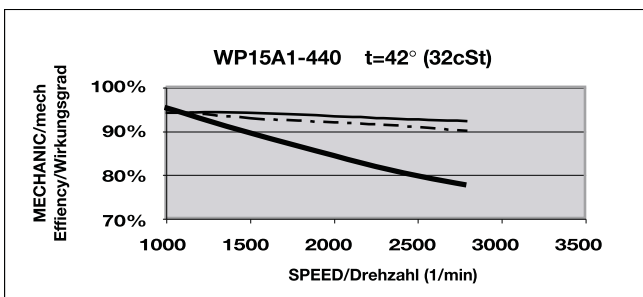
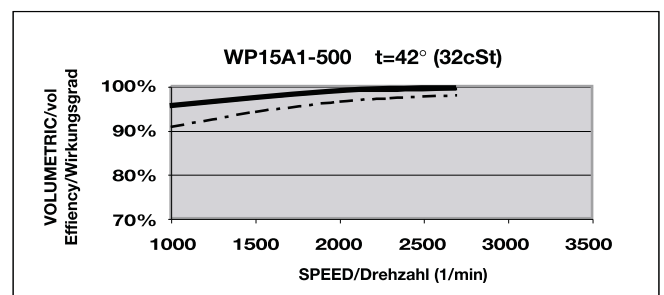
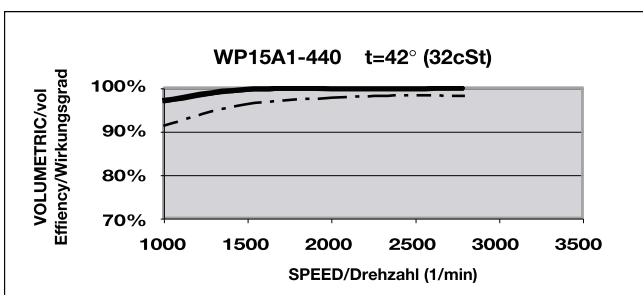
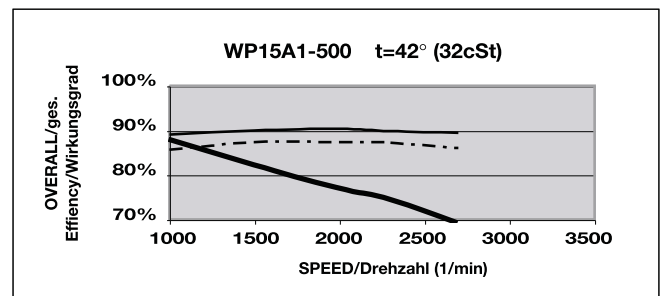
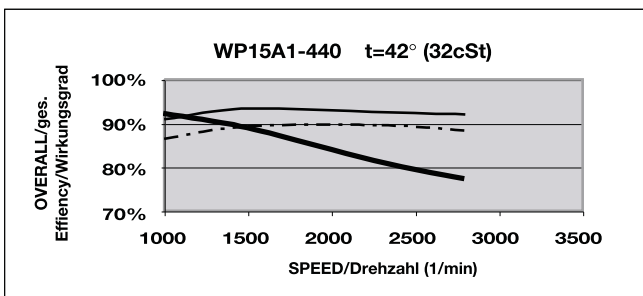
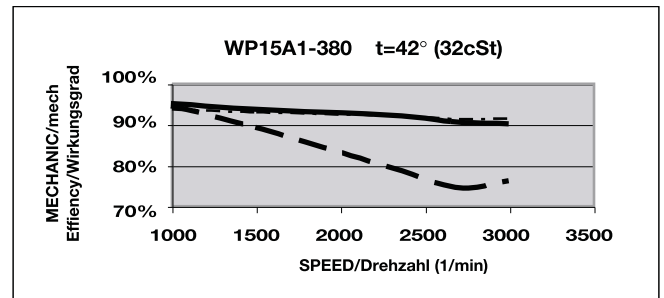
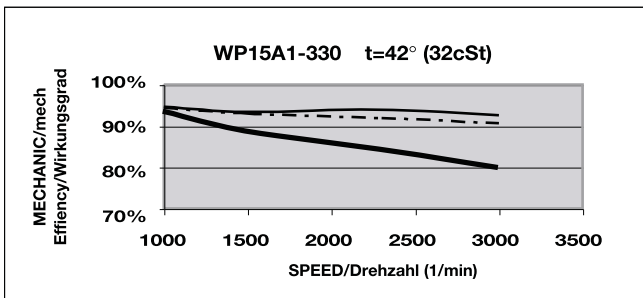
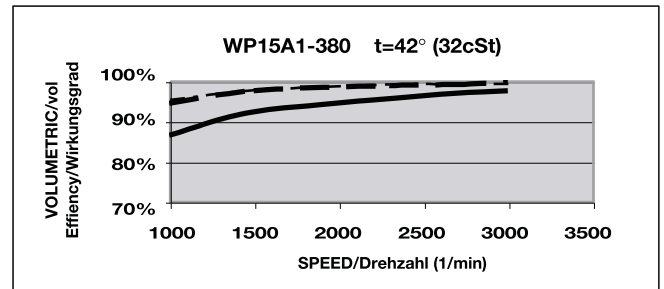
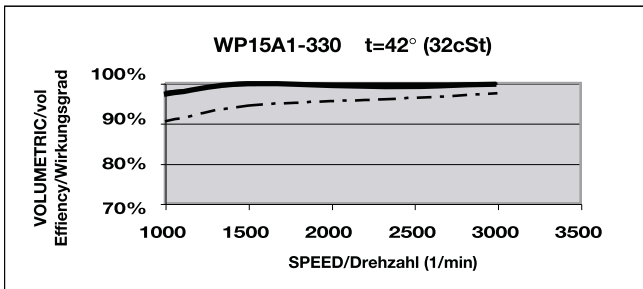
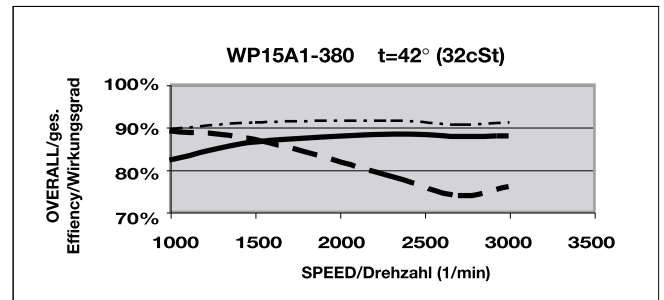
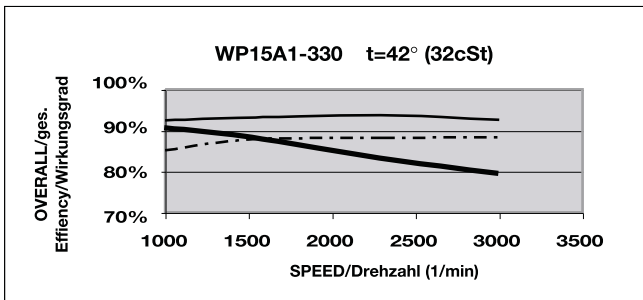

PRODUCT RANGE

HE Powerpacks

12/24/48 VDC 0.3 – 4.5 kW and
0.75 – 3 kW AC modular power packs

HE Box Powerpacks

12/24/48 VDC modular powerpacks
in weatherproof boxes

Pressure Switches

5 - 350 bar, connecting/disconnecting

W100 Hydraulic pumps

0,5 - 2,0 cc 227 bar

W300 Hydraulic pumps

0,8 – 5,7 cc 230 bar

W600 Hydraulic pumps / motors

3 – 12 cc 276 bar

W900 Hydraulic pumps / motors

5 – 31 cc/section 276 bar

Calma The new quiet pumps

6,2 - 23,7 cc/section 250 bar

WQ900 The quiet pumps

5 - 23 cc/section 230 bar

WP900X Hydraulic pumps

16 - 31 cc/section 276 bar

W1500 Hydraulic pumps / motors

19 - 50 cc/section 276 bar

F12 FERRA Heavy duty pumps

16 - 41 cc/section 276 bar

F15 FERRA Heavy duty pumps

19 - 50 cc/section 276 bar

F20/F30 (LS) Hydraulic pumps / motors

23 – 161 cc/section 276 bar

GPA Internal Gear pumps

1,7 – 63 cc/section 100 bar

GC Hydraulic pumps / motors

1,06 – 11,65 cc/section 276 bar

D Hydraulic pumps

3,8 – 22,9 cc/section 207 bar

H Hydraulic pumps

9,8 – 39,4 cc/section 207 bar

II-Stage Hydraulic pumps

4,2 – 22,8 cc/section 276 bar

Rotary Flow Dividers

3,8 – 13,3 cc/section 300 bar

Transmission pumps

www.concentricAB.com



Concentric Rockford Corp.

2222 15th Street
ROCKFORD, IL 61104
USA
Tel: +1-815 398 4400
Fax: +1-815 398 5977
E-mail: info.hydraulics.us@concentricAB.com

Concentric Hof GmbH

Postfach 1507
D-95014 HOF
Germany
Tel: +49-9281 895-0
Fax: +49-9281 87133
E-mail: info.hydraulics.eu@concentricAB.com

Concentric Skanes AB

Box 95
SE-280 40 SK. FAGERHULT
Sweden
Tel: +46-433 32400
Fax: +46-433 30546
E-mail: info.hydraulics.eu@concentricAB.com

Concentric Suzhou Co. Ltd.

47 Dongjing Industrial Park
9 Dong Fu Lu
SIP, Suzhou
Jiangsu
China 215123
Tel: +86 512 8717 5100
Fax: +86 512 8717 5101
info.chsh@concentricAB.com



Concentric is an innovator in flow control and fluid power, supplying proprietary systems and components for trucks, buses and industrial vehicles, worldwide. With 1,156 employees and yearly sales exceeding 1,977 million Swedish Kronor, Concentric AB is listed on the Stockholm Stock Exchange (www.concentricAB.com).

Concentric will not accept responsibility for any catalog errors and reserves the right to modify its products without prior notice. This also applies to products already ordered, provided that such modifications can be made without affecting technical specifications. All trademarks in this material are properties of their respective owners.